

CARBEST

INNOVATIONS FOR MOBILE LIFE

TV-Wandhalterung / Wall Mount



Simon Luxus
(# 493983)

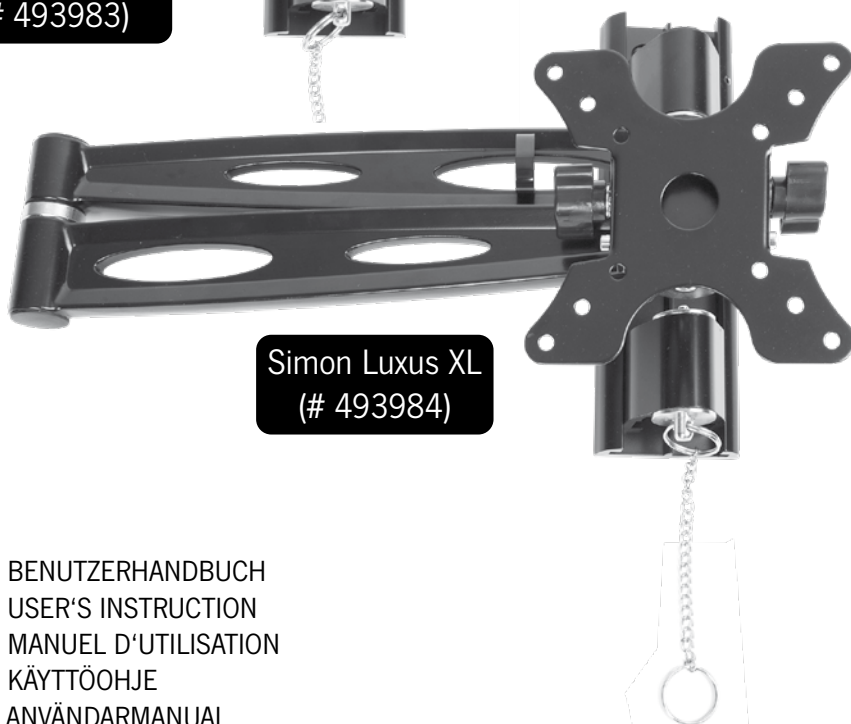

Simon Luxus XL
(# 493984)

- DE - BENUTZERHANDBUCH
- UK - USER'S INSTRUCTION
- FR - MANUEL D'UTILISATION
- FI - KÄYTTÖOHJE
- SE - ANVÄNDARMANUAL

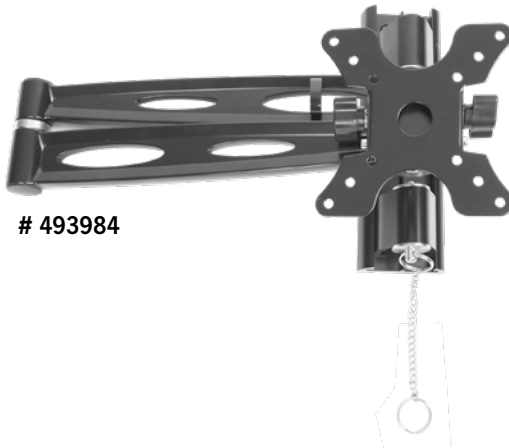

Lesen Sie mit Sorgfalt die Montageanleitung, bevor Sie mit der Installation beginnen.

WICHTIGE INFORMATIONEN ZUR SICHERHEIT

Installieren Sie den Monitorhalter mit Sorgfalt. Bitte lesen Sie erst die Montageanleitung komplett durch, bevor Sie mit der Installation des TV-Halters beginnen. Beachten Sie die Sicherheitshinweise.

Bitte rufen Sie einen qualifizierten Monteur:

- Wenn Sie die Installationsanweisung nicht verstanden oder Zweifel an der Sicherheit des Halters haben.
- Wenn Sie die Beschaffenheit des Untergrundes nicht kennen oder Zweifel an der Sicherheit des Halters haben.

Verwenden Sie den TV- oder Monitorhalter nur dem Zweck entsprechend. Bei falscher Verwendung als in dieser Anleitung angegeben oder bei falscher Montage lehnen wir jegliche Haftung bei Schäden ab.

DE - GEWÄHRLEISTUNG:

Der Gewährleistungszeitraum beträgt 36 Monate. Reimo behält sich das Recht vor, mögliche Fehler zu beseitigen. Die Garantie wird für alle Schäden ausgeschlossen, die durch fehlerhafte Verwendung oder unsachgemäße Handhabung entstanden sind.

Haftungsbeschränkungen: Reimo ist in keinem Fall für Begleitschäden, Folgeschäden oder indirekte Schäden, Kosten, Ausgaben, Nutzungsausfall oder Gewinnausfall haftbar. Der angegebene Verkaufspreis des Produkts stellt den entsprechenden Betrag der Haftungsbeschränkung von Reimo dar.

LIEFERUMFANG

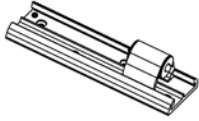

1x Wandhalterung (a)

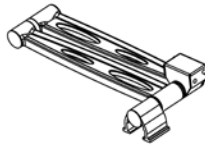

1x Schwenkarm (b)

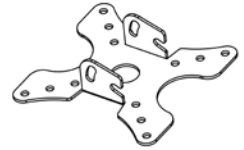

1x Monitoranschluss (c)



4x M4x12 Schraube (e)



4x M4x30 Schraube (f)



8x M4 Unterlegscheibe (g)



4x M4 Abstandhalter (h)



3x Kreuzschraube (i)

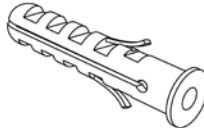

3x Dübel (j)

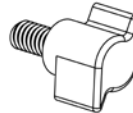

2x Sicherheitsschraube (k)

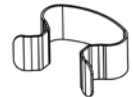

2x Klemme (l)

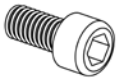

2x Imbusschraube (m)



2x Federscheibe (n)

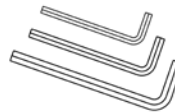

3x Imbusschlüssel (o)



2x M6 Unterlegscheibe (p)



WARNING

ACHTUNG!

Montieren Sie die Monitorhalterung sicher an einer senkrechten Wand. Wenn die Halterung nicht richtig montiert ist, kann der Monitor herunterfallen. Es kann zu Verletzungen und Sachschäden führen.

Benötigtes
Werkzeug

- 3.8mm Bohrer
- Kreuzschlitzschraubendreher

- 8mm Steinbohrer
- Wasserwaage

Achtung:

Die Montageteile und Komponenten, die in dieser Packung enthalten sind, sind nicht geeignet für den Einbau in Wänden mit Stahlbeschlägen oder aus Schlackenbeton. Wenn Sie Teile benötigen, die nicht enthalten sind, wenden Sie sich bitte an Ihren örtlichen Baumarkt, um die für Ihre Zwecke benötigten Teile zu erwerben.

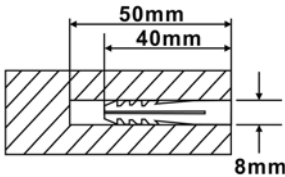
SCHRITT 1**MONTAGE DER WANDPLATTE AN DER STEINMAUER****STEINWAND**

Beachten Sie, dass die Sicherheits-schraube auf der Unterseite ist bei diesem Schritt

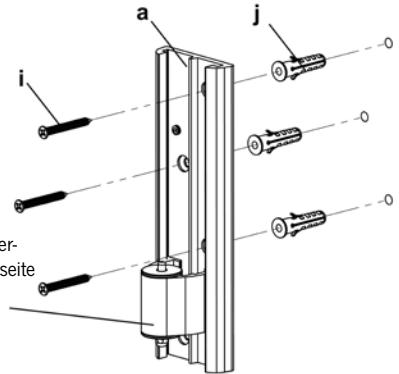
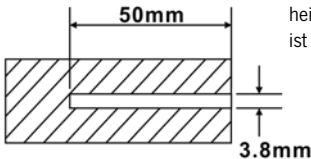
**HOLZWAND**

Beachten Sie, dass die Sicherheits-schraube auf der Unterseite ist bei diesem Schritt

**SCHRITT 2****EINSETZEN DES ZUSAMMENGESetzten ARMS AN DER WANDPLATTE**

Diagramm 2a



Diagramm 2b

1. Stellen Sie sicher, dass die Wandplatte fest an der Wand montiert ist.
2. Entfernen Sie die oben liegende Sicherheits-schraube mit dem beigefügten Im-busschlüssel wie in Diagramm 2a gezeigt
3. Setzen Sie den zusammengesetzten Arm ein und montieren Sie die Sicherheits-schraube wie in Diagramm 2b gezeigt.

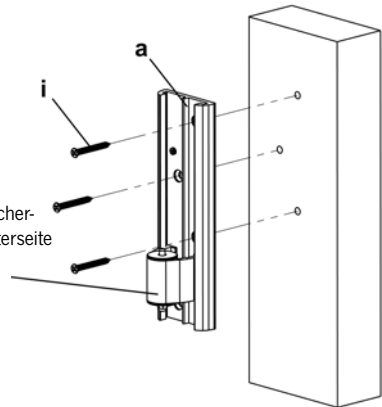
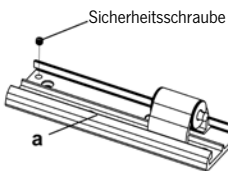
SCHRITT 3**MONTAGE DER MONITORHALTERUNG AM FERNSEHER**

Für ebene TV-Rückseite

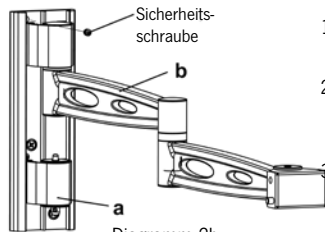
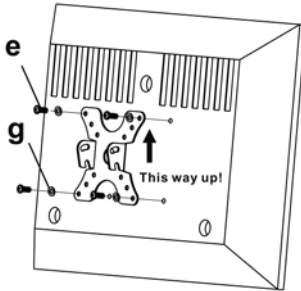
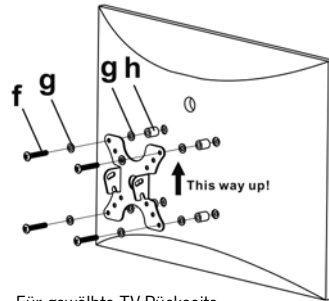

Für gewölbte TV-Rückseite

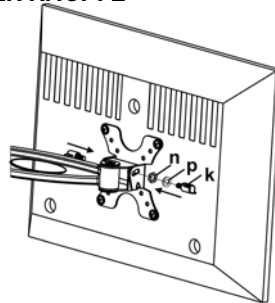
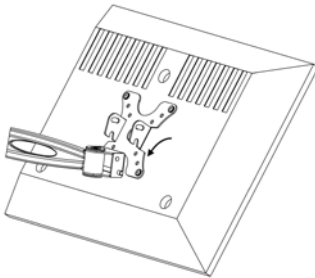
SCHRITT 4**MONTAGE DES MONITORS AN DER WANDPLATTE UND EINBAU DER KNÖPFE**

Anmerkung: Sie können die beigelegten Imbusschrauben (m) an Stelle der Plastikknöpfe verwenden, wenn Sie Probleme mit dem Schwenkwinkel des Fernsehers haben.

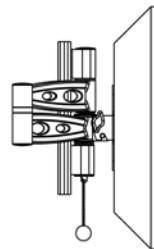
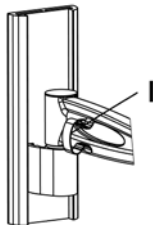
SCHRITT 5**BAUEN SIE DEN KABELFÜHRUNGSRING AM FERNSEHARM EIN UND FIXIEREN SIE DEN ARM IN DER GESCHLOSSENEN POSITION MIT DEM INTEGRIERTEN VERRIEGELUNGSSYSTEM**

Vielen Dank für das Vertrauen in unser Produkt - www.reimo.com



493983



493984

Carefully read all instructions before attempting installation.

IMPORTANT SAFETY INFORMATION

Install and operate this device with care. Please read this instruction before beginning the installation, and carefully follow all instructions contained herein. Use proper safety equipment during installation.

Please call a qualified installation contractor for help if you:

- If you don't understand these directions or have any doubts about the safety of the installation.
- If you are uncertain about the nature of your wall, consult a qualified installation contractor.

Do not use this product for any purpose or in any configuration not explicitly specified in this instruction. We hereby disclaims any and all liability for injury or damage arising from incorrect assembly, incorrect mounting, or incorrect use of this product.

UK - WARRANTY:

The warranty period is 36 months. Reimo reserves the right to rectify eventual defaults. The guarantee is excluded for all damages caused by faulty use or improper handling.

Liability limitations: In no case Reimo will be reliable for collateral-, secondary- or indirect damages, costs, expenditure, missed benefits or missed earnings. The indicated sales price of the product is representing the equivalent value of Reimo's liability limitations.

SUPPLIED PARTS LIST

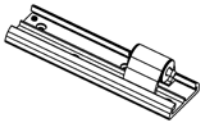

1x Wall Plate (a)

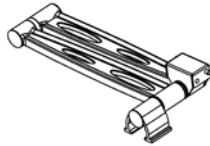

1x Arm Assembled (b)

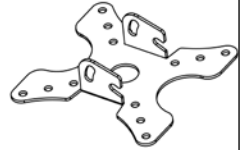

1x Monitor Bracket (c)



4x M4x12 Bolt (e)



4x M4x30 Bolt (f)



8x M4 Washer (g)



4x M4 Space (h)



3x Lag Bolt (i)

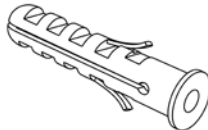

3x Concrete Anchor (j)

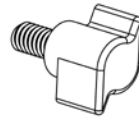

2x Safety Knob (k)

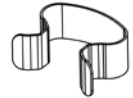

2x Cable Ring (l)

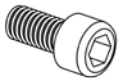

2x Allen Bolt (m)



2x Spring Washer (n)

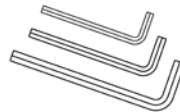

3x Allen Key (o)



2x M6 Washer (p)



WARNING

CAUTION!

This TV mount must be securely attached to the vertical wall. If the mount is not properly installed it may fall, resulting in possible injury and/or damage.

Tools Required

- 3.8mm Drill Bit
- Phillips Screwdriver
- 8mm Masonry Bit
- Carpenter's Level

Note:

The mounting components and hardware supplied in this package are not designed for installations to walls with steel studs or to cinder block walls. If the hardware you need for your installation is not included, please consult your local hardware store for proper mounting hardware for the application.

STEP 1

MOUNTING THE WALL PLATE TO THE WALL

BRICK MOUNT

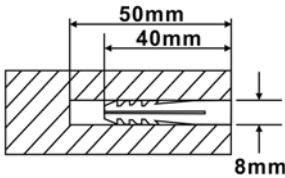

Make sure the locking head is on the bottom side when you do this step

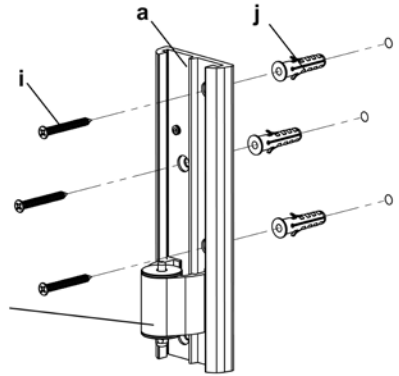

WOOD MOUNT

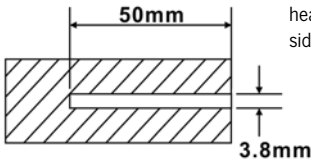

Make sure the locking head is on the bottom side when you do this step

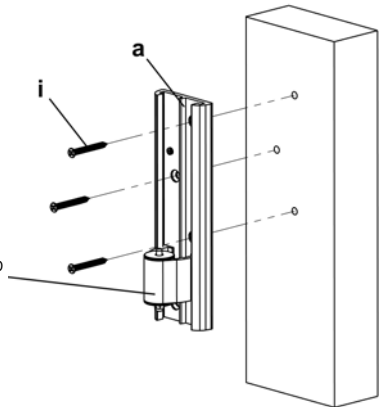

STEP 2

INSERT ARM ASSEMBLED TO WALL PLATE

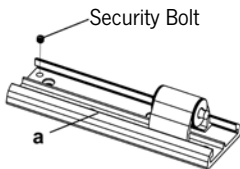

Diagram 2a

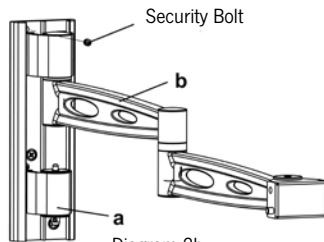
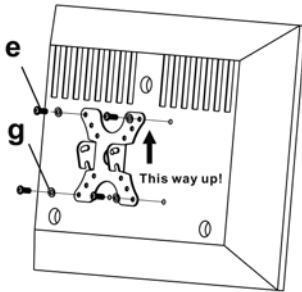

Diagram 2b

1. Before do this step, make sure the Wall Plate(a) had been fixed on the wall.
2. Remove the Security Bolt on the top by supplied Allen Key as showed in Diagram 2a.
3. Inter the Arm Assembled and install the Security Bolt as showed in Diagram 2b.

STEP 3

MOUNTING THE MONITOR BRACKET TO A TV



For Flat Back TV

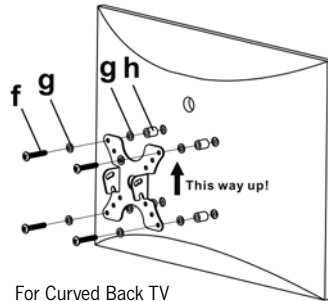

For Curved Back TV

STEP 4

ATTACHING TV TO WALL PLATE AND ADDING THE KNOBS

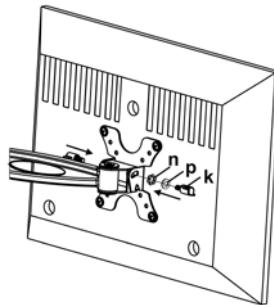
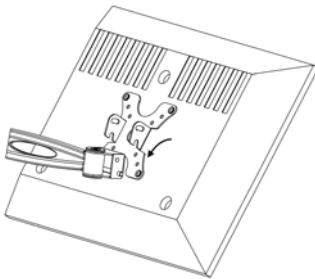

Remarks: You can use the supplied 2pcs Allen Bolt (m) to instead of plastic knobs if you have problem to fix the TV tilting angle

STEP 5

INSTALL THE CABLE MANAGEMENT RING ON THE ARMS AND FIX THE ARMS IN CLOSE POSITION BY INTEGRATED LOCKING SYSTEM

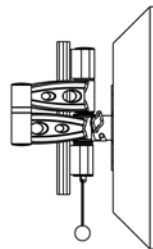
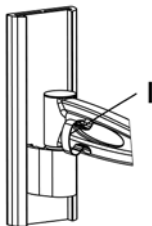

Thanks for choosing our products, enjoy the using - www.reimo.com



493983

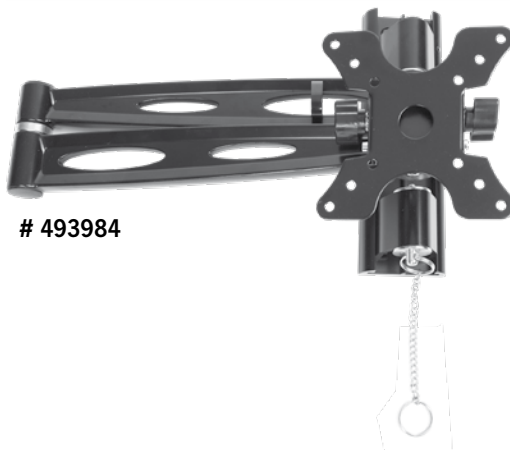

493984

Lisez attentivement la notice avant de commencer le montage.

IMPORTANTES CONSIGNES DE SECURITE

Installez et manipulez ce dispositif avec précaution. Lisez cette notice avant d'entreprendre le montage, suivez exactement toutes les instructions qu'elle contient.

Utilisez un équipement de sécurité correct pendant le montage.

Faites appel à un technicien de montage compétent qui devra vous aider dans les cas suivants :

- Si vous ne comprenez pas ces instructions ou si vous avez le moindre doute sur la sécurité de l'installation.
- Si vous ne connaissez pas la nature de votre cloison, faites appel à un technicien de montage compétent.

N'utilisez pas ce produit à d'autres fins ni dans une configuration qui ne serait pas explicitement spécifiée dans cette notice. Nous déclinons toute responsabilité pour les blessures ou dommages qui pourraient survenir suite à un mauvais assemblage, un mauvais montage ou une utilisation abusive de ce produit.

FR - GARANTIE :

La garantie est de 36 mois. Reimo se réserve le droit de corriger des défauts éventuels.

La garantie exclut tout dommage dû à une mauvaise utilisation ou à une manipulation inadaptée.

Limitation de la responsabilité: Reimo est en aucun cas responsable de dommages collatéraux, secondaires ou indirects, coûts, prestations non versées ou manques à gagner. Le prix de vente indiqué du produit représente la valeur équivalente de la limitation de responsabilité de Reimo.

LISTE DES PIÈCES FOURNIES

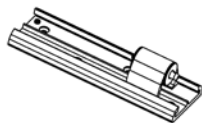

1x Plaque de support mural (a)

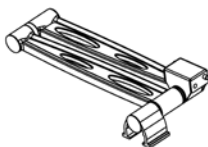

1x Bras assemblé (b)

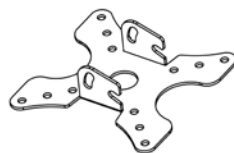

1x Porte-écran (c)



4x Boulon M4x12 (e)



4x Boulon M4x30 (f)



8x Rondelle M4 (g)



4x Douille d'écartement M4 (h)



3x Tire-fond (i)

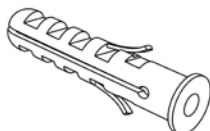

3x Cheville (j)

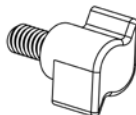

2x Bouton de sûreté (k)



2x Collier de câble (l)

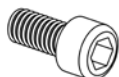

2x boulons à tête creuse hexagonale (m)



2x rondelles élastiques (n)

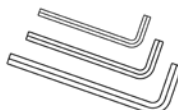

3x clés mâles coudées à six pans (o)



2x Rondelle M6 (p)



AVERTISSEMENT

ATTENTION

Ce kit de montage TV doit être solidement fixé à une cloison verticale. Si le montage n'est pas exécuté correctement, le téléviseur risque de tomber en provoquant des blessures et/ou des dommages.

Outils nécessaires

- Foret de 3,8 mm
- Tournevis à pointe cruciforme

- Foret de maçonnerie 8 mm
- Niveau de menuisier

Remarque :

Les pièces contenues dans ce paquet n'ont pas été conçues pour un montage sur des murs à poteaux d'acier ni sur des murs en blocs de cendre. Si le matériel nécessaire pour votre installation n'est pas compris, veuillez vous adresser à votre commerçant local qui vous fournira le matériel de montage correct.

ETAPE 1

MONTER LE SUPPORT MURAL AU MUR

MONTAGE DANS DE LA BRIQUE

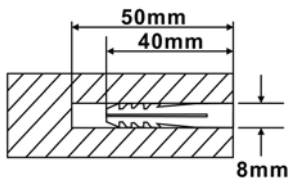

Vérifiez à ce stade que la tête de blocage est bien en bas.

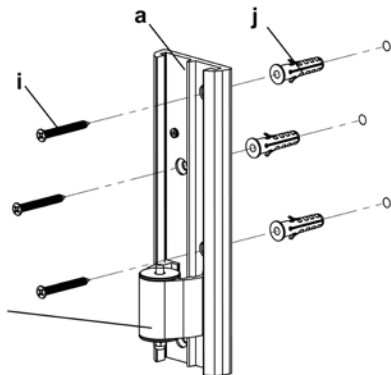

MONTAGE DANS DU BOIS

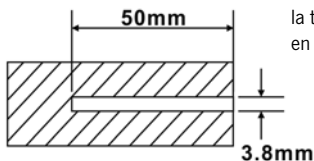

Vérifiez à ce stade que la tête de blocage est bien en bas.

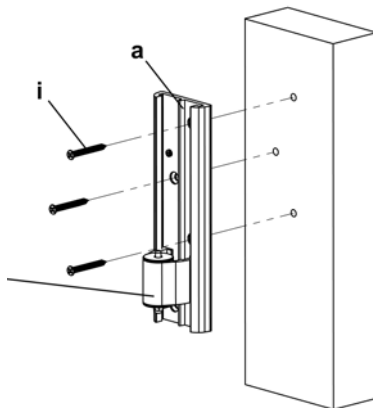

ETAPE 2

INSÉRER LE BRAS ASSEMBLÉ DANS LE SUPPORT MURAL

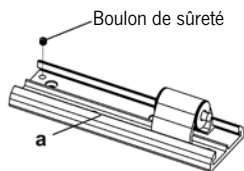

Illustration 2a

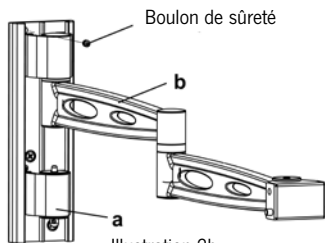
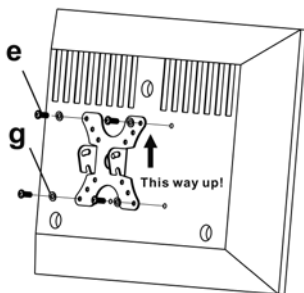
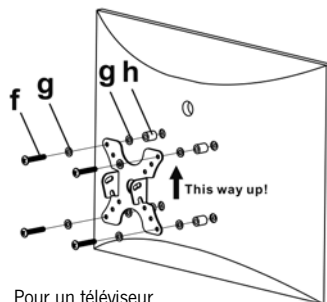

Illustration 2b

1. Avant ce stade, vérifiez que le support mural (a) est bien accroché au mur.
2. Enlevez le boulon de sûreté du dessus à l'aide de la clé mâle coudée fournie comme le montre l'illustration 2a.
3. Insérez le bras assemblé avant de remettre en place le boulon de sûreté comme le montre l'illustration 2b.

ETAPE 3**MONTER LE PORTE-ÉCRAN SUR LE TÉLÉVISEUR**

Pour un téléviseur à l'arrière plat

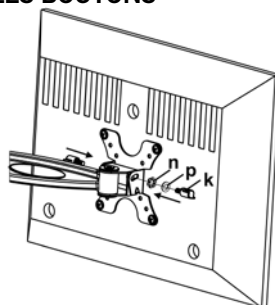
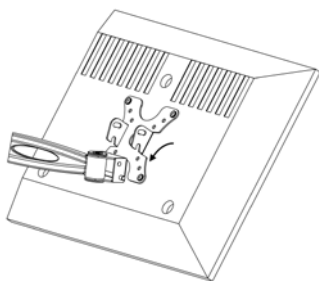

Pour un téléviseur à l'arrière incurvé

ETAPE 4**ATTACHER LE TÉLÉVISEUR AU SUPPORT MURAL ET INSÉRER LES BOUTONS**

Remarques : Vous pouvez vous servir des 2 boulons à tête creuse hexagonale fournis (m) au lieu des boutons en plastique si vous avez des problèmes pour attacher l'angle d'inclinaison du téléviseur.

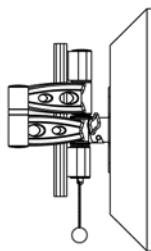
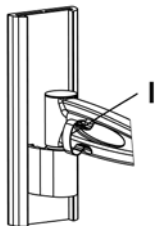
ETAPE 5**MONTER LE COLLIER DE CÂBLE SUR LES BRAS, ATTACHER LES BRAS EN POSITION FERMÉE AVEC LE SYSTÈME DE BLOCAGE INTÉGRÉ**

Merci d'avoir choisi nos produits, profitez de leur emploi – www.reimo.com



493983

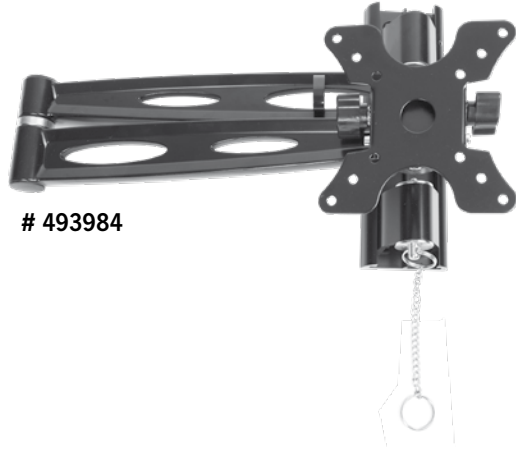

493984

Lue käyttöohje huolellisesti ennen kuin aloitat asennuksen

TÄRKEÄÄ TIETOA TURVALLISUUDESTA

Asenna teline huolellisesti. Lue ensin asennusohje kokonaan, ennen kuin aloitat asennuksen. Huomioi turvaohjeet.

Ota yhteys pätevään asentajaan:

- Jos et ole ymmärtänyt asennusohjeita tai epäilet telineen turvallisuutta.
- Jos et ole varma seinän luonteesta tai epäilet telineen turvallisuutta.

Käytä TV- telinettä vain sille osoitettuun tarkoitukseen.

Emme vastaa vääränlaisesta käytöstä tai asennuksesta aiheutuneista vammoista tai vahingoista

FI - TAKUU:

Takuujakso on 36 kuukautta. Reimo pidättää oikeuden korjata mahdolliset viat. Takuu ei koske mitään vahinkoja, jotka ovat aiheutuneet virheellisestä käytöstä tai virheellisestä.

Käsittelystä Vastuunrajoitukset: Reimo ei ole missään tapauksessa vastuussa rinnakkais-, toissijaisista tai epäsuorista vahingoista, kuluista tai kustannuksista, menetetyistä hyödyistä tai menetetyistä ansioista. Ilmoitettu myyntihinta tuotteelle vastaa Reimon vastuunrajoitusten arvoa.

TOIMITUKSEN SISÄLTÖ

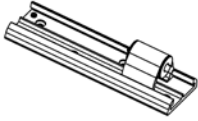

1x Seinäteline (a)

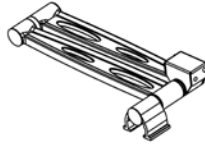

1x Taittuva varsi (b)

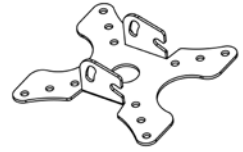

1x Näytön kiinnike (c)



4x M4x12 Ruuvi (e)



4x M4x30 Ruuvi (f)



8x M4 Aluslevy (g)



4x M4 Etäisyysosa (h)



3x Ristipääruuvi (i)

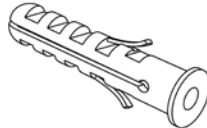

3x Tulppa (j)

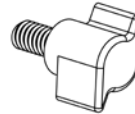

2x Turvaruuvi (k)

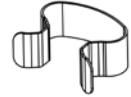

2x Puristin (l)

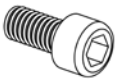

2x Kuusiokoloruuvi (m)



2x Jousialuslevy (n)

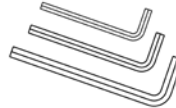

3x Kuusiokoloavain (o)



2x M6 Aluslevy (p)



WARNING

HUOMIO!

Asenna teline huolellisesti pystysuoraan seinään. Jos teline ei ole asennettu oikein, voi näyttö pudota. Tämä voi aiheuttaa loukkaantumisen tai esinevahinkoja.

Tarvittavat työkalut

- 3.8mm pora
- Ristipääruuvitaltta

- 8mm kiviporakone
- Vesivaaka

Huomio:

Asennusosat ja komponentit, jotka sisältyvät toimitukseen, eivät sovellu asennukseen teräsluottoon tai betoniseiniin. Jos tarvitset osia, jotka ei sisälly toimitukseen, käänny paikallisen rautakaupan puoleen.

STEP 1

SEINÄLEVYN ASENNUS KIVISEINÄÄN

KIVISEINÄ

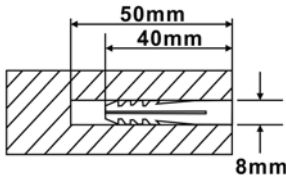

Varmista, että lukitysosa on alhaalla tässä vaiheessa

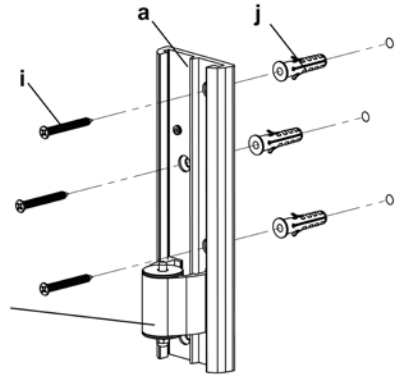

PUUSEINÄ

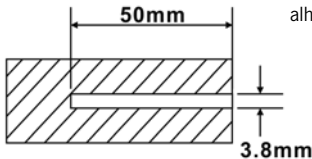

Varmista, että lukitysosa on alhaalla tässä vaiheessa

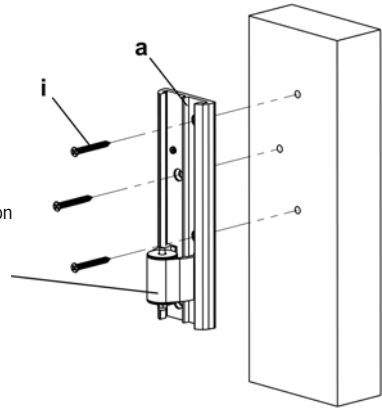

STEP 2

KOKOONTAITETUN VARREN ASETTAMINEN SEINÄLEVYYN

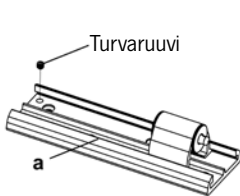

Kuva 2a

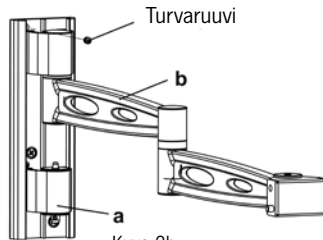

Kuva 2b

1. Varmista, että seinälevy on asennettu tiukasti seinään.
2. Poista ylhäällä oleva turvaruuvi mukana tulevalla kuusiokoloavaimella kuten kuvassa 2a
3. Aseta kokoontaitettu varsi ja asenna turvaruuvi kuten kuvassa 2b.

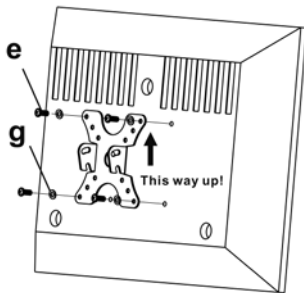
STEP 3**TELEVISION KIINNITTÄMINEN KIINNITYSLEVYYN**

Suoralle TV:n takaseinälle

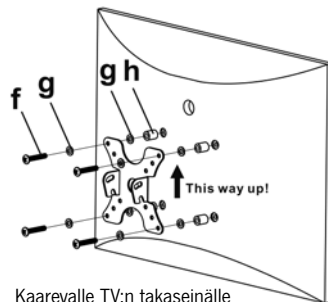

Kaarevalle TV:n takaseinälle

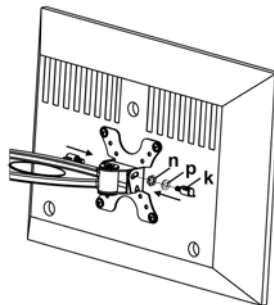
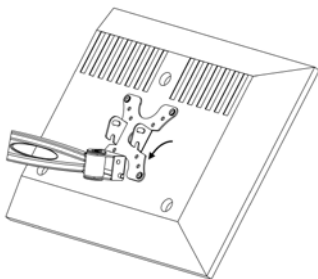
STEP 4**TELEVISION KIINNITTÄMINEN TELINEESEEN JA NAPPIEN ASENNUS**

Huomautus: Voit käyttää mukana tulevia kuusiokoloruuveja (m) muovinappien tilalla, jos sinulla on ongelmia television taivutuskulman kanssa

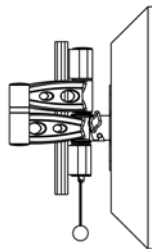
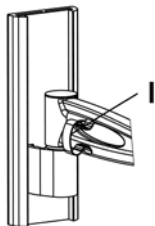
STEP 5**ASENNA KAAPELIN LÄPVIENTIRENGAS VARRESSA JA KIINNITÄ VARSIN SULKETTUUN ASENTOON MUKANA TULEVALLA LUKITUSJÄRJESTELMÄLLÄ**

Kiitos luottamuksesta tuotteeseemme – www.reimo.com



493983

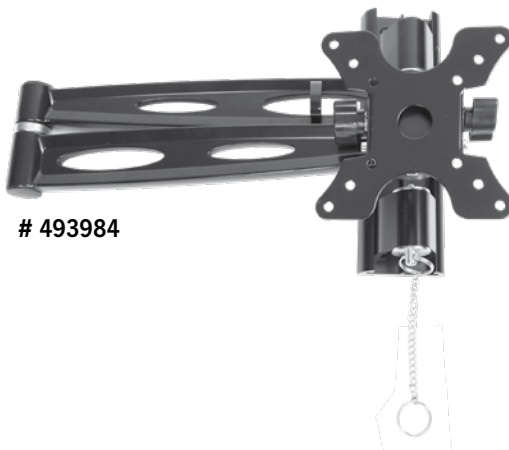

493984

Läs instruktionerna noga för installation.

VIKTIG SÄKERHETSINFORMATION

Installera monitorn innehavaren med omsorg. Vänligen läs monteringsanvisningen noggrant innan du börjar installationen av TV-hållare. Följ säkerhet instruktionerna.

Ring en kvalificerad tekniker:

- Om du inte förstår installationsanvisningarna eller hyser tvivel om säkerheten i innehavarens.
- Om du vet inte vilken typ av underlag eller hyser tvivel om säkerheten i innehavarens.

Använd TV eller bildskärm fäste enbart till rätt ändamål. Felaktig användning eller installation, som inte anges i handboken, avsäger vi oss allt ansvar för skada.

SE - GARANTI:

Garantiperioden är 36 månader. Reimo förbehåller sig rätten att korrigera eventuella fel. Garantin gäller inte för skador som orsakats av felaktig användning eller olämplig hantering

Begränsningar i garanti: Reimo kommer under inga omständigheter att kunna hållas ansvarig för följskador, sekundära eller indirekta skador, kostnader, utgifter, förlorade förmåner eller förlorade inkomster. Det angivna försäljningspriset för produkten motsvarar värdet för Reimos begränsade garanti.

LEVERANS INNEHÅLL

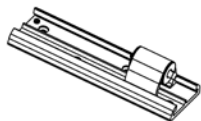

1x Väggfäste (a)

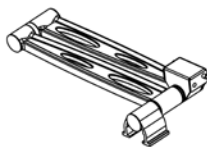

1x Sväng arm (b)



1x Monitor anslutning (c)



4x M4x12 Skruv (e)



4x M4x30 Skruv (f)



8x M4 Bricka (g)



4x M4 Avståndsdel (h)



3x Krysskruv (i)

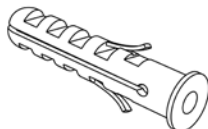

3x Dymling (j)

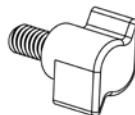

2x Säkerhetskruv (k)



2x Klämma (l)

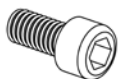

2x Insexskruv (m)



2x Fjäderbricka (n)

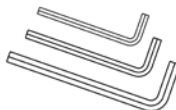

3x Insexnyckel (o)



2x M6 Bricka (p)



WARNING

OBS

Installera monitor fäste ordentligt i vertikal vägg. Om fästet är inte korrekt monterad, kan skärmen falla. Det kan orsaka skador och saksador.

Verktyg
Som behövs

- 3.8mm borrar
- Stjärnskruvmejsel

- 8mm stenbollar
- Nivå

Obs:

Montering av delar och komponenter som ingår i detta paket är inte lämpligt för montering i väggar med stålbeslag eller slagg betong. Om du behöver delar som inte ingår, kontakta din lokala järnaffär för att köpa de nödvändiga delar.

STEP 1

INSTALLERA VÄGGPLATTAN PÅ STENVÄGG

STENVÄGG

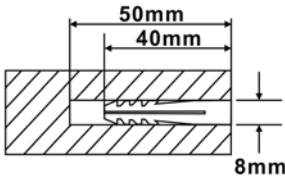

Observera att säkerhetsskruv är på undersidan

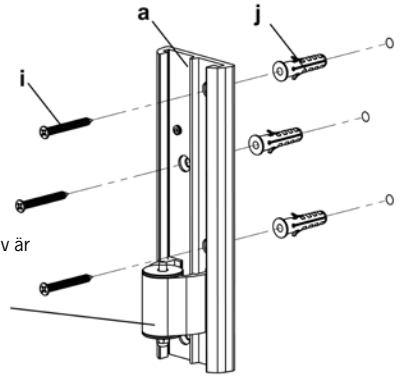

TRÄVÄGG

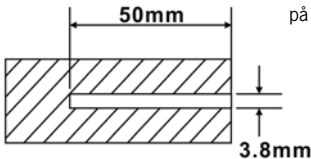

Observera att säkerhetsskruv är på undersidan

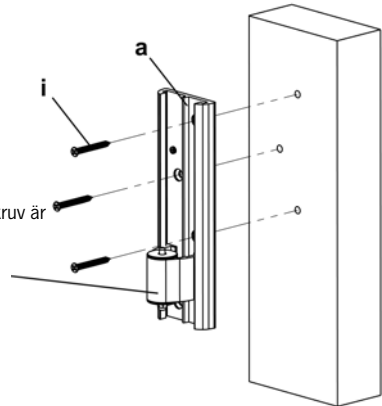

STEP 2

MONTERING AV SAMMANSATTA ARM PÅ VÄGGPLATTA

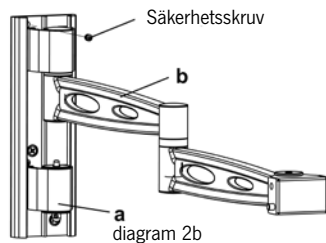
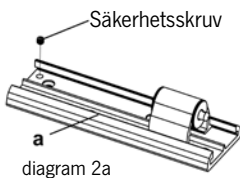

1. Se till att väggplatta är fast monterad på väggen.
2. Ta bort topp läggande säkerhetsskruren med den medföljande insexnyckeln som visas i diagram 2a
3. Placera arm och montera säkerhetsskruv som visas i diagram 2b

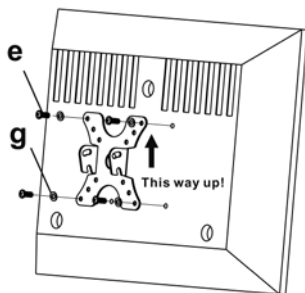
STEP 3**MONTERA FÄSTE PÅ TV**

För platt TV rygg

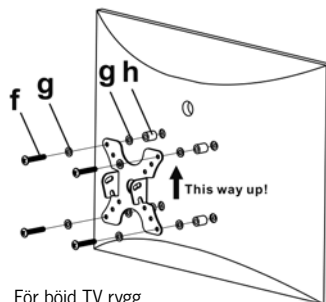

För böjd TV rygg

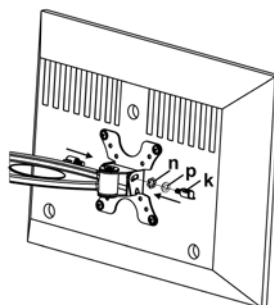
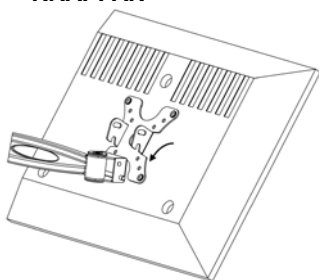
STEP 4**MONTERING AV BILDSKÄRMEN PÅ VÄGGPLATTA OCH INSTALLATION AV KNAPPAR**

Obs: Du kan använda de medföljande insexskruvarna (m) i stället för plast knappar, om du har problem med vridningsvinkel på TV

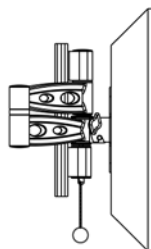
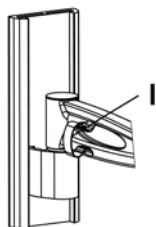
STEP 5**MONTERA KABELGENOMFÖRINGEN RINGAR PÅ TV OCH FIXA ARM TILL STÄNGT LÄGE MED INBYGDA LÅSSYSTEM**

Tack för ditt förtroende för vår produkt – www.reimo.com



REIMO REISEMOBIL-CENTER GMBH
63329 EGELSBACH · BOSCHRING 10
GERMANY · WWW.REIMO.COM
MADE IN CHINA