

# E-Temperature

Monitor your climate

PRODUCTHANDLEIDING  
PRODUCT MANUAL  
PRODUKTHANDBUCH  
MANUEL D'UTILISATION

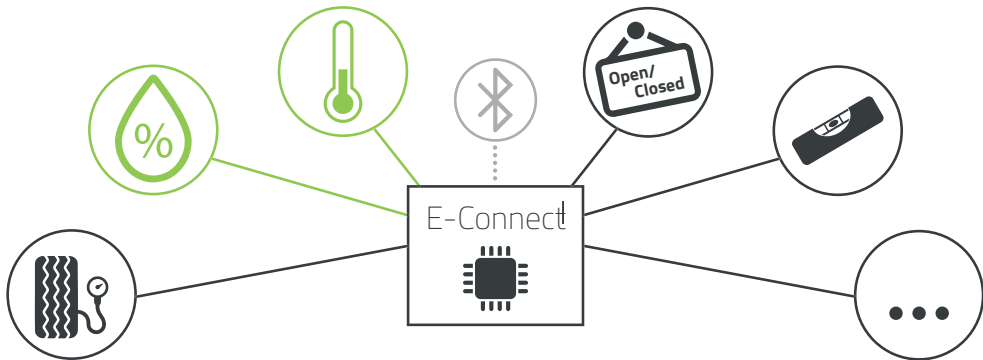



E-Trailer B.V.

Molengraaffsingel 12

2629 JD Delft

The Netherlands

[info@E-Trailer.nl](mailto:info@E-Trailer.nl)

[www.E-Trailer.nl](http://www.E-Trailer.nl)



E-TRAILER

Made for



iPad



iPhone



ANDROID



Bluetooth®

NL	
Voltage	3V
Type batterij	CR2477
Batterijduur	2 jaar
Gewicht	19 g
Afmeting	39 x 39 x 14 mm
Min. temp.	-20°C
Max. temp.	+60°C

GB	
Voltage	3V
Type of battery	CR2477
Duration of battery	2 years
Weight	19 g
Size	39 x 39 x 14 mm
Min. temp.	-20°C
Max. temp.	+60°C

DE	
Spannung	3V
Akku Typ	CR2477
Akku Lebensdauer	2 Jahre
Gewicht	19 g
Größe	39 x 39 x 14 mm
Min. temp.	-20°C
Max. temp.	+60°C

FR	
Voltage	3V
Type de batterie	CR 2477
Durée de la batterie	2 années
Poids	19 g
Dimensions	39 x 39 x 14 mm
Min. temp.	-20°C
Max. temp.	+60°C

NL Inclusief | GB Including  
DE Inklusive | FR Inclusif

NL Benodigd | GB Needed  
DE Erforderlich | FR Requis

1.



1x

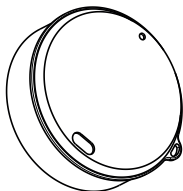

1x

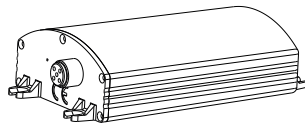

E-Connect



+

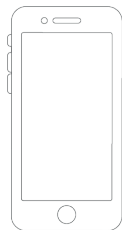

[www.e-trailer.nl/app](http://www.e-trailer.nl/app)

NL Gefeliciteerd met de aankoop van uw E-Temperature! Dit heeft u nodig om aan de slag te gaan.  
GB Congratulations on the purchase of your E-Temperature! You need this to get up and running.  
DE Herzlichen Glückwunsch zum Kauf von Ihrem E-Temperature! Dies benötigen Sie, um sich an die Arbeit zumachen.  
FR Félicitations pour l'achat de votre E-Temperature! Voici ce dont vous avez besoin pour commencer.

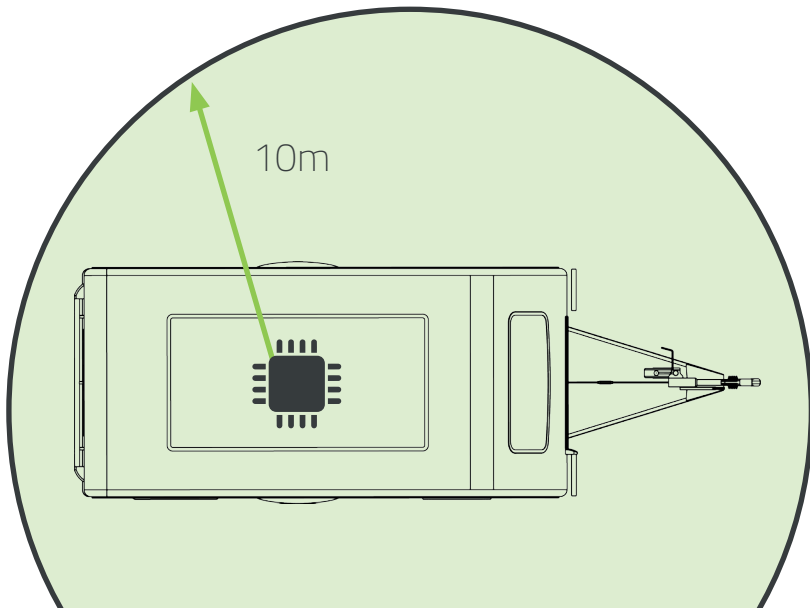

- NL Voordat u begint, dient uw smartphone binnen het bereik van de E-Connect te zijn.
- GB Before you start, ensure your smartphone is within range of E-Connect.
- DE Bevor Sie beginnen, muss Ihr Smartphone im Empfangsbereich von E-Connect sein.
- FR Avant de commencer, assurez-vous d'être à portée du signal E-Connect.

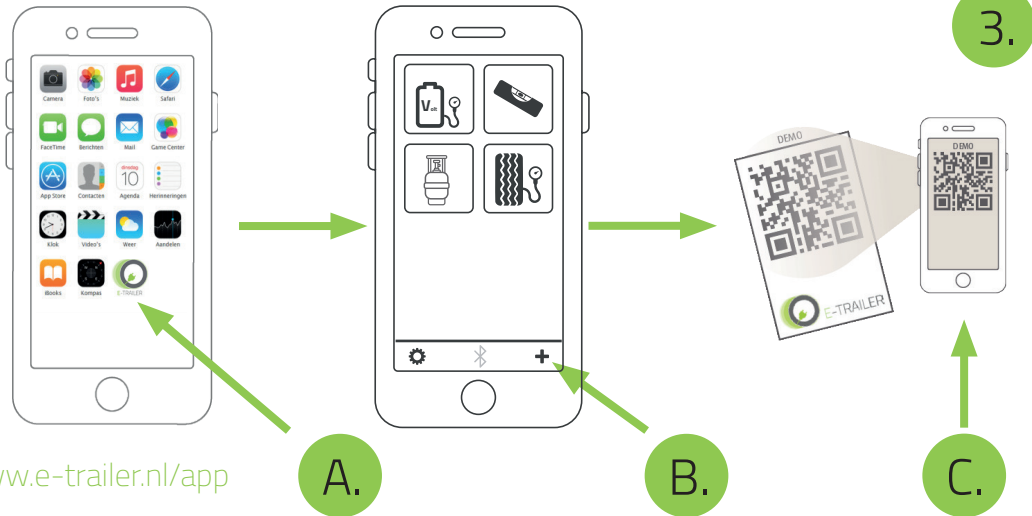

- NL Open de app (A) en klik op **+** in het hoofdmenu van de app (B). Scan de unieke QR-Code (C) en volg de instructies in de app.
- GB Open the app (A) and press **+** in the main menu of the app (B). Scan the unique QR Code (C) and follow the instructions in the app.
- DE Öffnen Sie die App (A) und klicken Sie auf **+** im Hauptmenü der App (B). Scannen Sie den speziellen QR-Code (C) und folgen Sie den Anweisungen in der App.
- FR Ouvrez l'application (A) et cliquez sur **+** dans le menu principal de l'application (B), scannez le code QR unique (C) et suivez les instructions dans l'application.

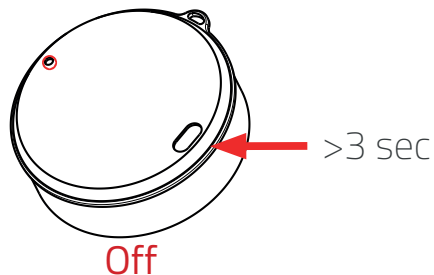
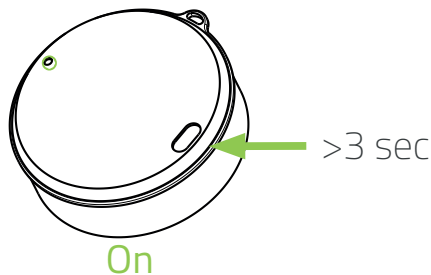



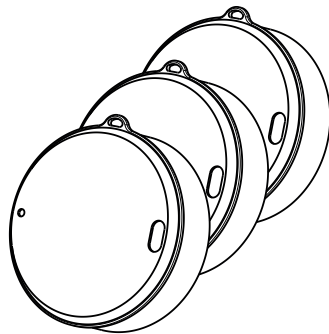
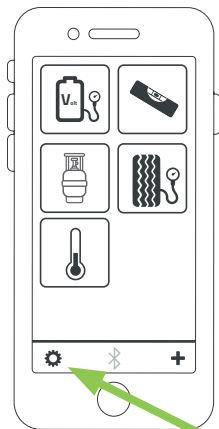
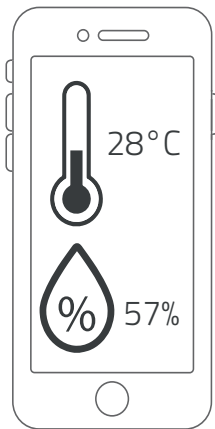

- NL Houdt de aan- en uitknop minimaal 3 seconden ingedrukt om de E-Temperature in of uit te schakelen. Schakel de E-Temperature uit om de batterijduur te verlengen
- GB Press and hold the on/off button for at least 3 seconds to switch the E-Temperature on or off respectively. Please turn off the E-Temperature to improve the battery life.
- DE Drücken und halten Sie den Ein/Aus-Schalter für drei Sekunden, um den E-Temperature an- oder auszuschalten. Schalten Sie E-Temperature aus, um die Batterie zu schonen.
- FR Appuyez sur le bouton marche/ arrêt et maintenez-le enfoncé pendant au moins 3 secondes pour allumer ou éteindre E-Temperature. Veuillez éteindre E-Temperature pour améliorer la durée de vie de la batterie.

5.



A.

- NL Ga naar de instellingen  in de app (A) en klik op E-Gaslevel. Hier kunt u uw E-Gaslevel personaliseren.
- GB Navigate to settings  in the app (A) and select the E-Gaslevel. Here you can personalize your E-Gaslevel.
- DE Wählen Sie in den Einstellungen  der App (A) den Punkt E-Gaslevel aus. Hier können Sie E-Gaslevel Ihren persönlichen Wünschen anpassen.
- FR Accédez aux paramètres  dans l'application (A), sélectionnez E-Temperature. Ici vous pouvez personnaliser votre E-Temperature. Vous pouvez ajouter plusieurs E-Temperatures.



A.

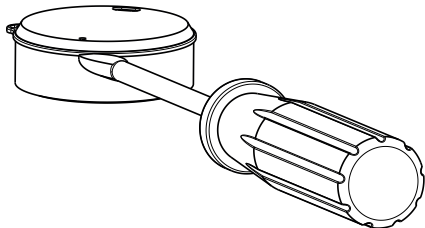

B.

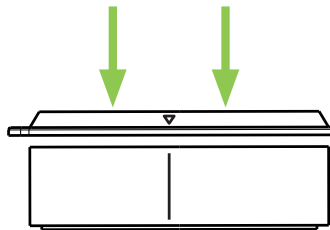

- NL Open de E-Temperature doormiddel van een schroevendraaier (A) om de batterij (CR 2477) te vervangen. Let bij het sluiten op de markering (driehoek en streep) (B).
- GB Open the E-Temperature using a screwdriver (A) to replace the battery (CR 2477) when necessary. Pay close attention when closing the E-Temperature, the marks must be aligned properly (triangle and stripe) (B).
- DE Öffnen Sie das E-Temperature-Modul mit einem Schraubendreher (A), um die Batterie (CR 2477) zu ersetzen. Achten Sie beim Schließen des E-Temperature auf die Markierungen (Dreieck und Streifen) (B).
- FR Ouvrez E-Temperature à l'aide d'un tournevis (A) pour remplacer la pile (CR 2477). Faites attention en fermant la E-Temperature, les marques doivent être alignées (triangle et bande) (B).